

PIN/TAB
1490-03P

APPLICATION

STRIPLINE TRANSITION LAUNCH

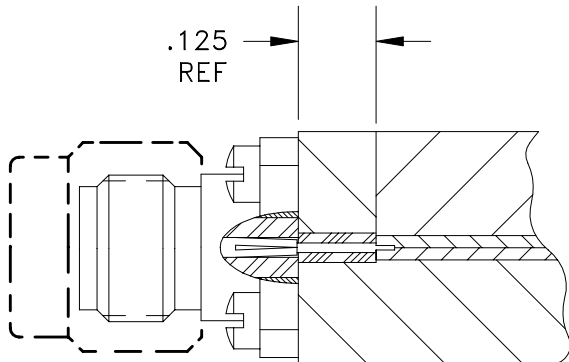

PIN/TAB BeCu
UNS-C17300 PER ASTM-B-196/197.
GOLD PLATE PER MIL-G-45204.

MATERIAL & FINISH

A		RELEASE	9/28/01	B.LANE
REV.	ECN	DESCRIPTION	DATE	APPVD

DRAWN SS	DATE 9/11/01	APRVD. B.LANE	DATE 9/28/01
-------------	-----------------	------------------	-----------------

TITLE	1490-03P
	PIN/TAB (.009) DIA X .160 LONG .015 TAB



Southwest Microwave, Inc.
9055 South McKemy Street
Tempe, Arizona 85284-2946
Telephone (480) 783-0201
Fax (480) 783-0360

SCALE NONE	DWG. NO. 79P57129	REV. A
SHEET 1 OF 1		