

NOTE: Information herein is believed by Southwest Microwave, Inc. to be accurate. However, Southwest Microwave assumes no responsibility for any omissions or errors or inaccuracies for its use or for any infringements of patents or other rights of third parties that may result from its use. Data is intended for informational purpose only and does not constitute a contract of sale or any express or implied warranty, including any warranty of merchant ability or fitness for a particular purpose.

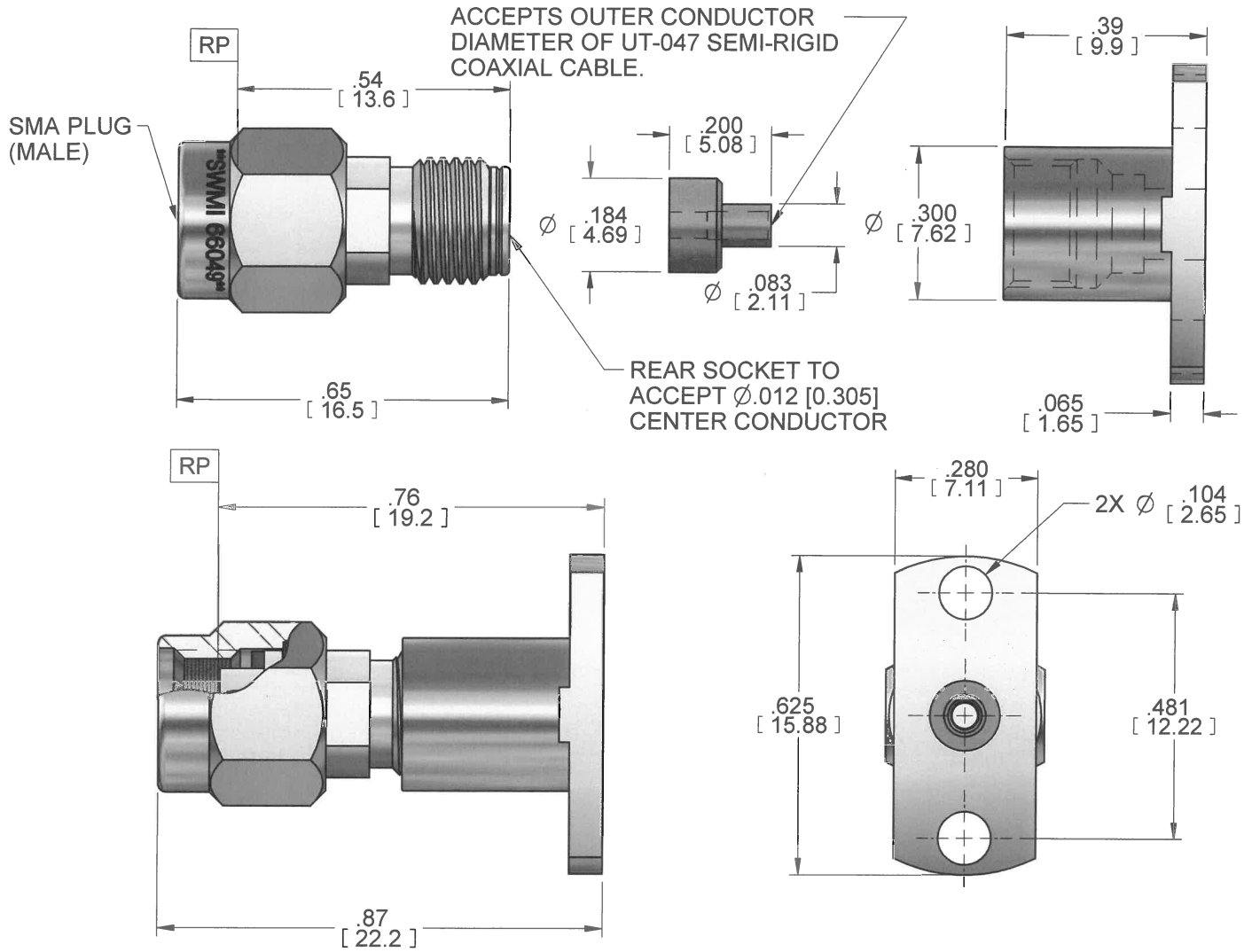

CABLE ASSY. INSTR.:	91S59287
CONTACT GAGING SPEC.:	91B52104
SPECIFICATION:	91B52089
INTERFACE:	91B52002
SPECIFICATION GROUP	DRAWING NO.

HOUSING:	STEEL, CRES ALLOY UNS-30300 PER ASTM A582
COUPLING NUT:	PASSIVATE PER ASTM A967
FLG CBL NUT:	
CONTACT :	BeCu UNS-C17300 PER ASTM B196 GOLD PLATE PER MIL-DTL-45204
DIELECTRIC:	VIRGIN PTFE FLUOROCARBON PER ASTM D1710
DIELECTRIC:	ULTEM 1000 PER ASTM D5205
RETAINING RING:	BeCu UNS-C17300 PER ASTM B194
GASKET:	SILICONE RUBBER PER ZZ-R-765
CABLE ADP:	C360 BRASS ALLOY UNS-C36000 PER ASTM B16 GOLD PLATE PER MIL-DTL-45204
ITEM	MATERIAL & FINISH

1. ALL DIMENSIONS ARE IN INCHES. ALL ANGLES ARE IN DEGREES. DIMENSIONS SHOWN IN BRACKETS [XXX] ARE IN MILLIMETERS.

NOTES: UNLESS OTHERWISE SPECIFIED.

REV A	RELEASED	DATE: 2/20/12	APRVD. PLC	DATE: 2/20/12	TITLE SMA PLUG (M) 2 HOLE REAR MOUNT FLANGE CABLE CONNECTOR ACCEPTS .047 SEMI-RIGID CABLE												
 <p>Southwest Microwave, Inc. 9055 South McKemy Street Tempe, Arizona 85284-2946 Telephone (480) 783-0201 Fax (480) 783-0360</p>					<table border="1"> <tr> <td>DRN BY: EJO</td> <td>DATE: 10/5/11</td> <td>MODEL NO. 201-515SF</td> <td>REV. A</td> </tr> <tr> <td colspan="2">SCALE: 3:1</td> <td>DWG. NO. 79B60704</td> <td></td> </tr> <tr> <td colspan="2">SHEET: 1 OF 1</td> <td></td> <td></td> </tr> </table>	DRN BY: EJO	DATE: 10/5/11	MODEL NO. 201-515SF	REV. A	SCALE: 3:1		DWG. NO. 79B60704		SHEET: 1 OF 1			
DRN BY: EJO	DATE: 10/5/11	MODEL NO. 201-515SF	REV. A														
SCALE: 3:1		DWG. NO. 79B60704															
SHEET: 1 OF 1																	