

NOTE: Information herein is believed by Southwest Microwave, Inc. to be accurate. However, Southwest Microwave assumes no responsibility for any omissions or errors or inaccuracies for its use or for any infringements of patents or other rights of third parties that may result from its use. Data is intended for informational purpose only and does not constitute a contract of sale or any express or implied warranty, including any warranty of merchant ability or fitness for a particular purpose.

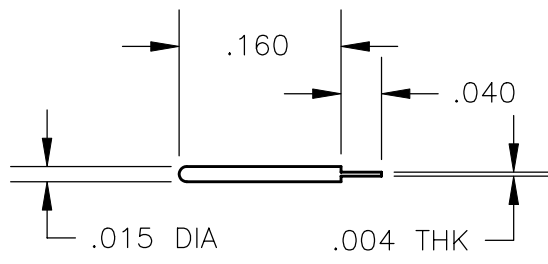

PIN/TAB
290-25P

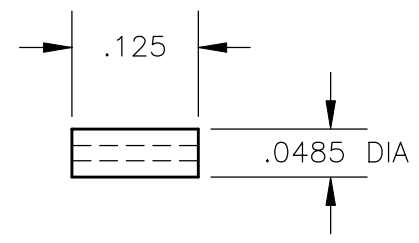

DIELECTRIC
290-25D

APPLICATION

STRIPLINE TRANSITION LAUNCH

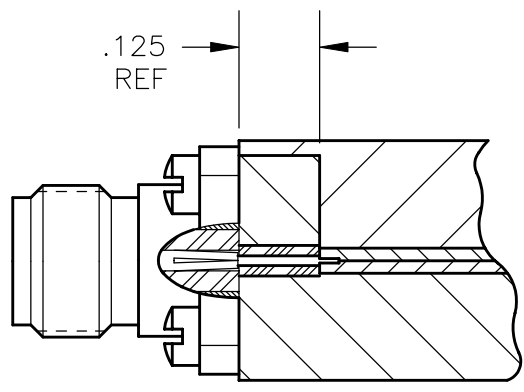

CATALOG CONNECTOR MODELS

- 211-01,-14,-22SF
- 212-01,-08,-21SF
- 213-01,-13,-26SF
- 214-01,-13,-26SF

MICROSTRIP

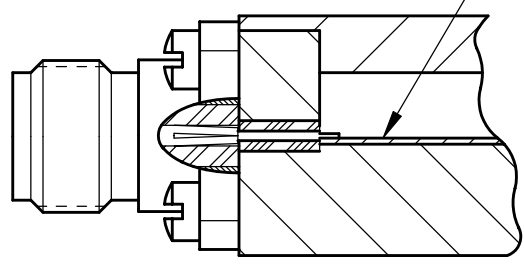

PIN/TAB: BeCu
UNS-C17300 PER ASTM-B-196/197.
GOLD PLATE PER MIL-G-45204.

DIEL: VIRGIN TFE FLUOROCARBON PER
ASTM-D-1710, TYPE 1, GRADE 1,
CLASS B, AND ASTM-D-1457.

MATERIAL & FINISH

REV: A3 ECN: 6300 DATE: 6-30-95

DRAWN DK	DATE 9-2-94	APRVD. GH	DATE 9-14-94
-------------	----------------	--------------	-----------------

TITLE
290-25G
PIN/TAB, .015 DIA X .160L X .040 TAB
WITH .125 LONG DIELECTRIC



Southwest Microwave, Inc.
9055 South McKemy Street
Tempe, Arizona 85284-2946
Telephone (480) 783-0201
Fax (480) 783-0360

DATE 9/94	DWG. NO. 79B53557	REV. A4
SHEET 1	OF 1	