

# END LAUNCH TEST BOARDS

End Launch Connectors DC to 110 GHz

	27 GHz	40GHz	50 GHz	67 GHz	110 GHz
.008 R04003 microstrip	<b>B4003-8M-27</b>	<b>B4003-8M-40</b>	<b>B4003-8M-50</b>	<b>B4003-8M-50</b>	
.008 R04003 GCPW	<b>B4003-8C-27</b>	<b>B4003-8C-40</b>	<b>B4003-8C-50</b>	<b>B4003-8C-50</b>	
.030 R04350 GCPW	<b>B4350-30C-27</b>	<b>B4350-30C-40</b>	<b>B4350-30C-50</b>		

PCB connector layout assistance is available upon request. Test boards listed above are the only boards offered.

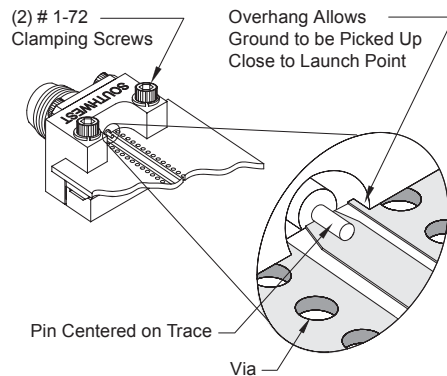
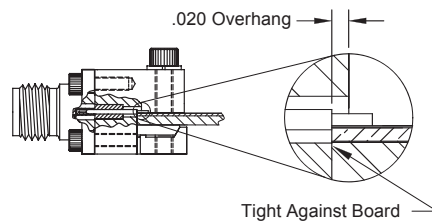
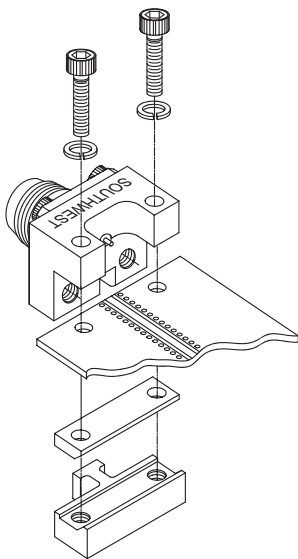
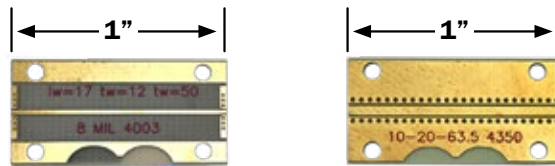

## TYPICAL ASSEMBLY

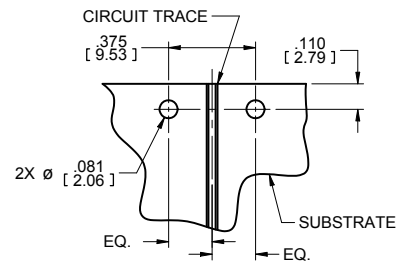

## .500 TRANSITION BLOCK PCB FOOTPRINT

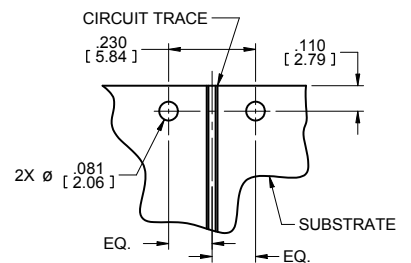

## .350 TRANSITION BLOCK PCB FOOTPRINT

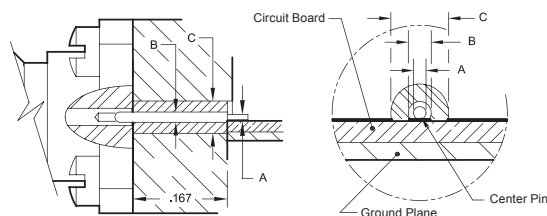

## DEFINITIONS: DIM A, B, AND C