

Hermetic Seal Transition for Flange Mount Connectors

Recommended Hole Pattern, Tools and Installation Fixtures for Optimum VSWR.

* To be determined by user for type and amount of solder preforms. Surface must be plated to provide a solderable surface.

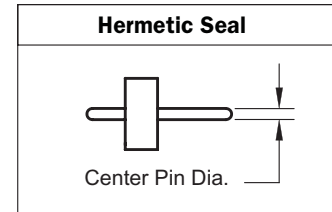

Refer to hermetic seal page.

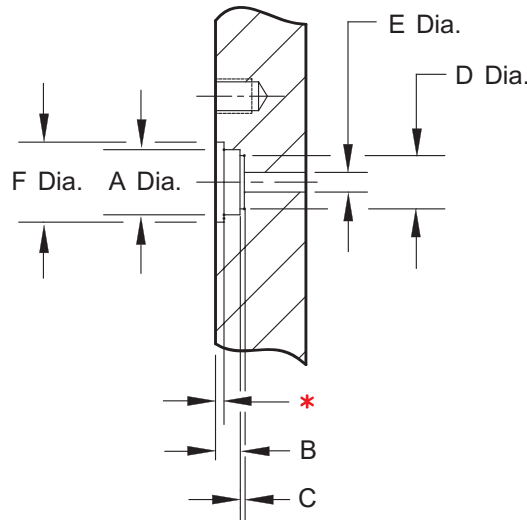

Not for use with Kovar.

Hermetic Seal No.	Center Pin Dia.	A	B	C	D	E	F	C'Bore Tool No.
490-00G	.036	$\frac{.272}{.274}$	$\frac{.061}{.062}$	$\frac{.018}{.022}$	$\frac{.148}{.152}$	$\frac{.0823}{.0822}$.288	
290-02G	.020	$\frac{.161}{.160}$	$\frac{.062}{.061}$	$\frac{.010}{.009}$	$\frac{.126}{.124}$	$\frac{.0465}{.0455}$.178	T-291-4
290-01G	.018	$\frac{.113}{.112}$	$\frac{.062}{.061}$	$\frac{.009}{.007}$	$\frac{.086}{.084}$	$\frac{.042}{.041}$.130	T-291-3
290-00G	.015	$\frac{.102}{.101}$	$\frac{.0645}{.0635}$	$\frac{.007}{.005}$	$\frac{.080}{.078}$	$\frac{.035}{.034}$.120	T-291-2
290-06G 290-07G	.012	$\frac{.079}{.078}$	$\frac{.057}{.056}$	$\frac{.0035}{.0025}$	$\frac{.067}{.065}$	$\frac{.028}{.027}$.098	T-291-5 ** T-53029-2
1490-13G 1490-14G 1490-15G	.009	$\frac{.072}{.074}$	$\frac{.057}{.058}$	$\frac{.006}{.008}$	$\frac{.0302}{.0322}$	$\frac{.0205}{.0211}$.091	T-1491-1 ** T-53029-4

** 0.9 mm (SSBT)

**Hermetic Seal
Installation**

Connector Mounting Hole Patterns and Seal Solder Tools For Flange Mount Connectors

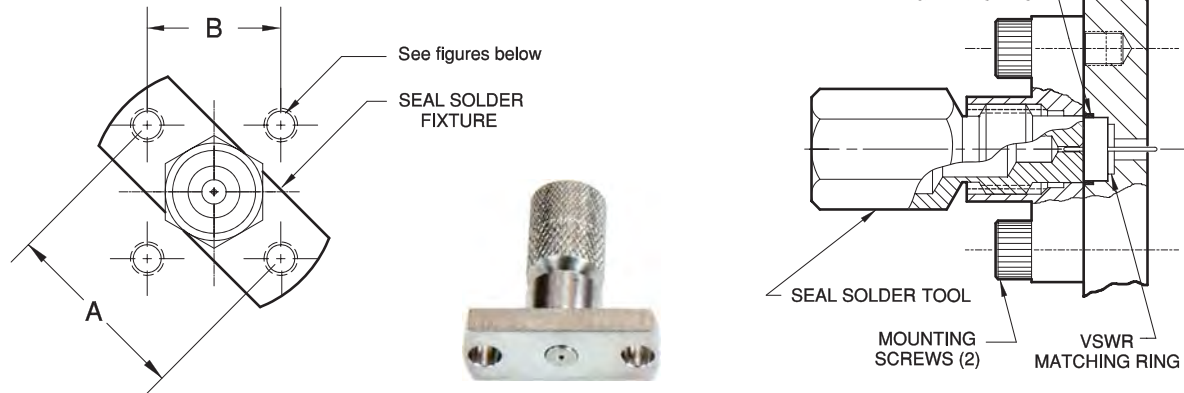

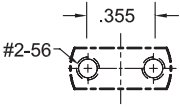
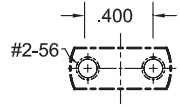
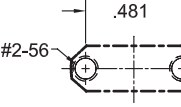
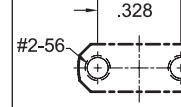
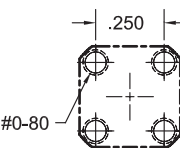
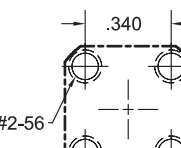
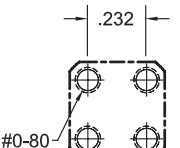
		SSMA ONLY				
A DIM.		.355	.400	.481	.328	.328
2 Hole Flange	SEAL CTR. PIN DIA.					
	Solder Tool No.	---	---	---	---	---
	.036	---	---	---	---	---
	.020	T-212-5	T-212-8	T-212-2	---	---
	.018	T-212-6	T-212-9	T-212-3	T-112-4	T-112-2
	.015	T-212-4	T-212-7	T-212-1	T-112-6	T-112-5
	.012	T-212-15	T-212-13	T-212-11	T-112-3	T-112-1
	.009	T-1412-15	T-1412-13	T-1412-11	T-112-8	T-112-7
B DIM.		.250		.340		.232
4 Hole Flange						
		#0-80		#2-56		#0-80

Seal installation using solder fixture

A. Center fixture and locate solder preform.

1. Bottom centering tool in fixture housing with small end protruding beyond fixture base.
2. Install preform around centering tool protrusion.
3. Hold fixture and preform upright. Align centering tool protrusion with seal counter bore in panel.
4. Secure fixture to panel with 2 mounting screws. The preform should be properly centered in the solder groove.

Note:

Other soldering techniques may be utilized. Other methods should still achieve proper seal center conductor centering and position seal front surface orthogonal to connector axis to provide 360° of outer conductor contact for effective microwave performance.

B. Install and solder seal.

1. With preform located and fixture securely mounted. Remove centering tool.
2. Position seal center conductor onto tool with connector end in.
3. Reinstall centering tool, hand tighten to bottom seal in panel.
4. Apply heat to flow solder.
5. Remove fixture.
6. Clean.
7. Install connector.

**Hermetic Seal
Installation**